

Data Sheet



Article number: 201146840

Description: E+G Stainless steel lock pin
GN 114.6-8-40

Measures

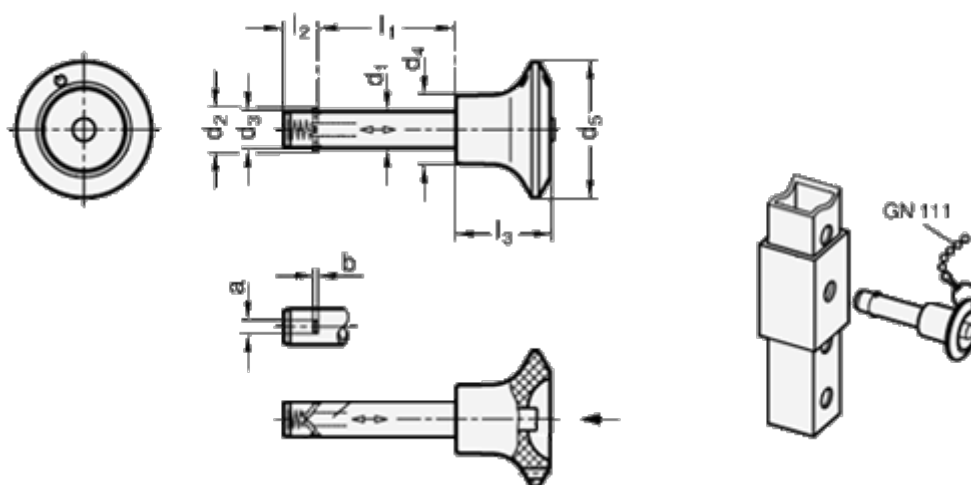

a = 2.8

d1 = 8

d2 = 10.4

d3 = 7.9

d4 = 15.0

d5 = 30

l1 = 40

l2 = 8.4

l3 = 21

Resilience (N) = 28